

HFD Compressor/Distractor

Dial mechanism helps allow precise control of inserted wires—for maintaining a position, compressing or distracting

- ▶ A .125" (3,2 mm) pin can be used in the holes of the thumbwheel for leverage
- ▶ Small: Two hole sizes allow for pin size selection: .045" (1,1 mm) & .062" (1,6 mm)
- ▶ Large: Two hole sizes allow for pin size selection: .082" (2,0 mm) & .125" (3,2 mm)
- ▶ Radiolucent arms are a PEEK/Carbon Fiber composite
- ▶ All models are steam sterilizable

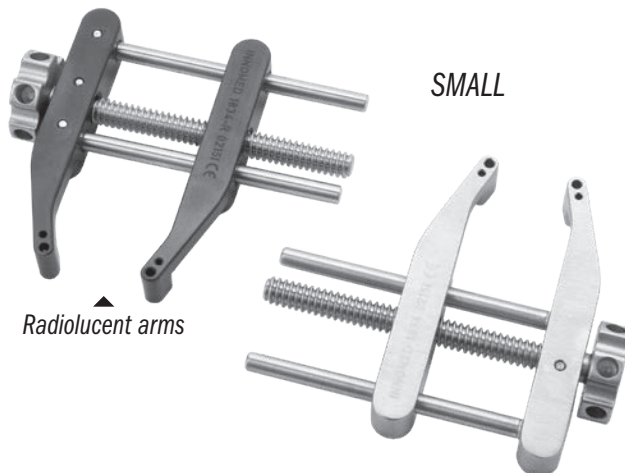

Radiolucent arms

SMALL

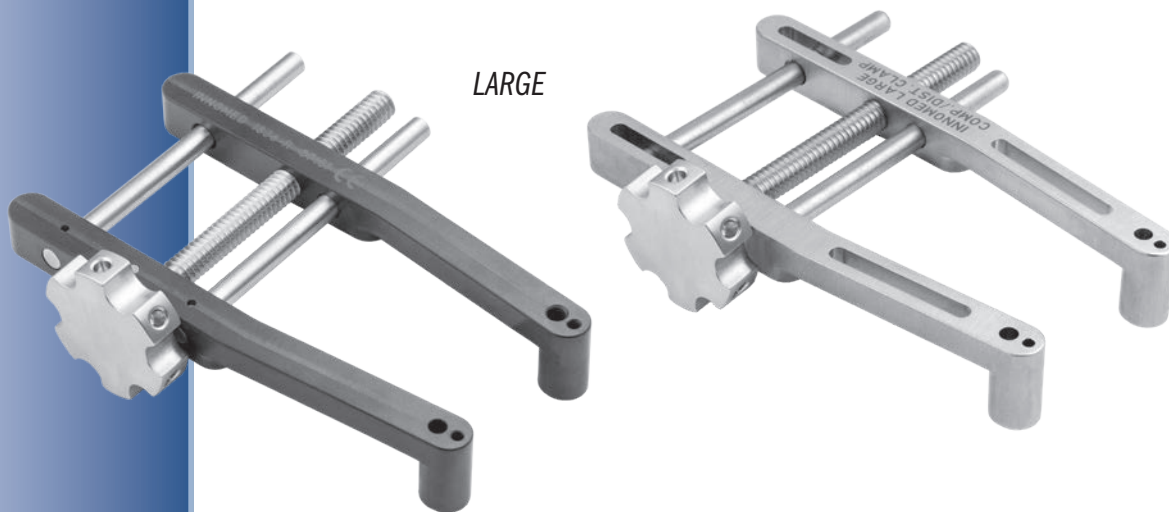

LARGE

Radiolucent arms

PRODUCT NO'S:	
SMALL	LARGE
1834 [Small – All Stainless Steel] Dimensions: 51 mm x 57 mm Maximum Arm Opening: 1.35" (3,4 cm)	1836 [Large – All Stainless Steel] Overall Length: 4" (10,2 cm) Maximum Arm Opening: 2.25" (5,7 cm)
1834-R [Small With Radiolucent Arms] Dimensions: 51 mm x 57 mm Maximum Arm Opening: 1.35" (3,4 cm)	1836-R [Large With Radiolucent Arms] Overall Length: 4" (10,2 cm) Maximum Arm Opening: 2.25" (5,7 cm)



ISO 9001:2008 • ISO 13485:2003

FREE TRIAL ON MOST INSTRUMENTS

Scan to
Launch Our
Website



103 Estus Drive, Savannah, GA 31404
www.innomed.net info@innomed.net

912.236.0000 Phone
912.236.7766 Fax

Innomed-Europe Tel. +41 41 740 67 74
Fax +41 41 740 67 71



1.800.548.2362